

SZ receptacle

Fixed receptacle, fixed inside of case with nut.

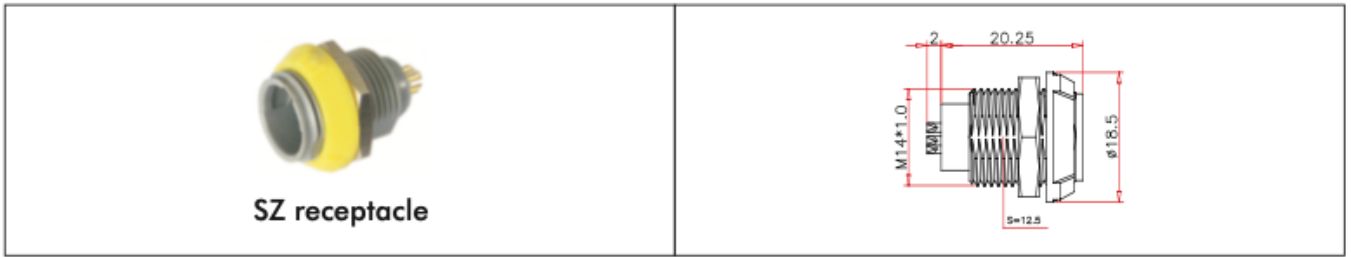

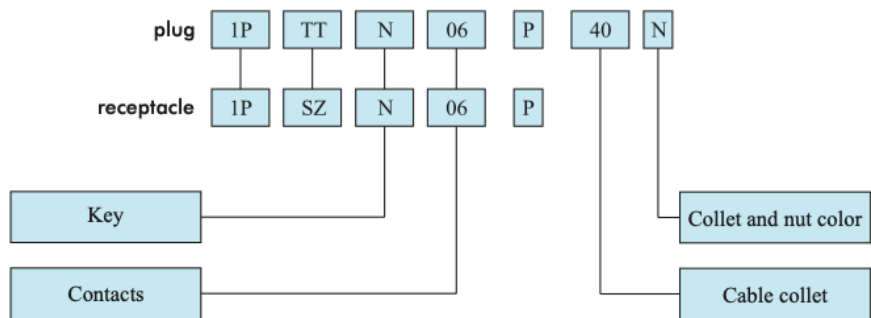



Numbering rules:

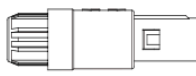

P Series connector with the following main features:

- 1) Smart push-pull self-latching system;
- 2) Multicore types 2 to 14 pins;
- 3) Solder or PCB contacts;
- 4) High packing density for space saving;
- 5) Collet nut and socket nut with the same color to avoid mismatching.

Key

Key of plug	Diagram			
	0° 	40° 	60° 	80° 
Key code	N	A	B	C

Color of nut

Color	Blue	Gray	Yellow	Black	Red	Green
Code	A	G	J	N	R	V

Collet

Collet code	Cable diameter
42	2.2~4.0
52	5.0~4.0
62	6.0~5.0